

Best Management Practices for Trapping River Otter in the United States

Updated 2021





Figure OT1: River Otter
(*Lontra canadensis*)

Best Management Practices (BMPs) are carefully researched educational guides designed to address animal welfare and increase trappers' efficiency and selectivity. The extensive research and field-testing used to develop BMPs are described in the Introduction section of this manual. The evaluation methods used to develop BMPs have been standardized, enabling them to be easily updated and revised as new traps and techniques become available. All traps listed in the BMPs have been tested and meet performance standards for animal welfare, efficiency, selectivity, practicality and safety.

Trapping BMPs provide options, allowing for discretion and decision making in the field. BMPs are meant to be implemented in a voluntary and educational approach and do not present a single choice that can or must be applied in all cases. BMPs are the product of ongoing work that may be updated as additional traps are identified through future scientific testing.

The River Otter at a Glance

Characteristics

The river otter (*Lontra canadensis*) (Figure OT1) is a member of the Mustelidae family and along with sea otters, is the most aquatic of the North American mustelids. The body is long, cylindrical and muscular with a short, stout neck that is nearly the same diameter as the broadly flattened head. Adults weigh between 11 and 33 pounds and range from 35 to 54 inches in total length. Males are generally about 25 percent heavier than females. The pelage is made up of short, soft, dense underfur that is protected by longer, stiff guard hairs. The coloration is a rich, glossy shade of brown, but may be black or even blonde. Typically, the fur is lighter colored on the cheeks, throat and belly. River otters have physical features that make them especially adapted to an aquatic existence; webbed toes, non-retractile claws, small rough bumps on the heel pad of each hind foot for traction on slippery surfaces, a dorso-ventrally flattened tail, and valves in their noses and ears that close when they are submerged. Long, sensitive facial whiskers allow them to be successful hunters in dark or murky waters. Like other mustelids, river otters have anal musk glands that release a pungent odor when they are frightened.

Range

The river otter ranges throughout most of North America north of Mexico, with the exception of the arid southwest and frozen Arctic. In the United States, their range includes Alaska, Pacific northwest, Great Lakes states, Mississippi River Valley, New England, Atlantic and Gulf coastal states.

Habitat

River otters live in and along lakes, wetlands, rivers and streams exploiting a variety of aquatic habitats. They thrive in mountainous and coastal regions and may be found in both freshwater and marine environments. Otters do not construct their own dens, but instead rely on logjams, beaver lodges, the bank dens of beaver and muskrat, and natural features such as cavities in tree roots, undercut banks and fallen timber for their den sites. The river otter prefers habitat where dense riparian vegetation is present adjacent to waterbodies, relying on the escape and resting cover provided.



Food Habits

The river otter is primarily carnivorous, and like most other predators, has teeth especially adapted to grasping, cutting and shearing. Consuming a wide variety of prey, otters are keen hunters and normally avoid eating carrion. The otter is a specialist at catching fish, and typically, fish are the preferred food source though the diet varies seasonally and regionally. Crustaceans (crayfish and crabs) may be a very important component of the diet in regions where they occur and at certain times of year may compose 100 percent of the diet. Amphibians, reptiles, birds (shorebirds and waterfowl), insects and even mammals such as muskrat and beaver may occasionally be consumed by river otter as well.

Reproduction

The river otter breeding season occurs in late winter to early spring with March and April being the peak months. The gestation period is between 290 to 380 days, due to delayed implantation (a period of arrested embryonic growth), with young typically being born in late winter to early spring. River otters produce only one litter per year, with an average litter size of two to four young. Females may successfully breed beginning in their first year, but males are typically not successful breeders until they are at least three years or older. Pups are born toothless and blind in a den that is usually a subterranean burrow. After being born, pups emerge from the den at about two months of age and are fit to leave the birthing area by three months. The young remain with the female in a family unit until seven to eight months of age, or just prior to the birth of a new litter. The rearing of young is left solely to the female. The siblings may remain together until 12 to 13 months of age, at which time they normally disperse. River otters can live for more than 20 years, but typical life span is likely less than 10 years in the wild.

Populations

Along with so many other North American wildlife species, the story of the resurgence in river otter numbers is quickly becoming one of the great success stories of modern conservation. Unregulated harvest, degradation of water quality and habitat, and human encroachment led to a severe decline in otter populations by 1900. Most populations were vastly reduced, with some being entirely extirpated. However, as a result of the dedicated efforts of concerned biologists and state wildlife agencies, reintroductions, protection, improved habitat quality, and regulated harvest, otter populations began to rebound in the later half of the 20th century. At present, river otter populations are expanding across their range. Indeed, in some drainages, reestablished otter populations have become over-abundant and threaten valuable fisheries. Careful management by state wildlife agencies is needed—usually through regulated harvest.



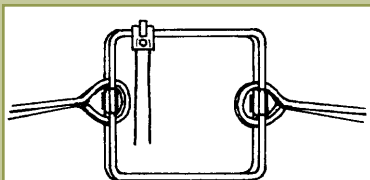

Figure OT1a: Moving the trigger to one side of a bodygrip trap increases the chance an otter can get through

How to Avoid Capturing Otter When Trapping Beaver

Because otter and beaver often use the same habitat, and harvest regulations often vary by species, there may be times/places when trappers need to avoid capturing otter. While no method can completely eliminate accidental otter captures, there are methods that can help reduce the risk of accidental capture, and considering these methods will improve the ability to manage both beaver and otter populations. The following ideas are offered as a guide to improving selectivity, recognizing that each may have advantages/disadvantages depending on the situation and location. There may be other methods equally (or more) useful and trappers are encouraged to use whatever method seems most effective for the given situation.

When there is a need to avoid otter while beaver trapping, consider the following ideas:

- Stay alert for the presence of otter sign on your trap line.
- Be cautious about using trap sets at high probability otter travel-ways, particularly dam crossings, inlets and outlets to ponds/lakes, narrow streams and ditches that connect to other water bodies, crossover trails along shorelines, dikes and culverts and the entrances to inactive beaver bank dens or lodges.
- Use baited beaver sets where possible.
- Avoid using beaver lures that may also attract otters to the set.
- Consider using a “side-parallel” position (Figure OT1a) for the trigger wires on beaver bodygrip traps. Also consider the use of tension-adjustable triggers, using two “side-parallel” triggers (one on each side), and two-way triggers only (those that don’t spring when pushed sideways).
- Offset the trigger to one side on a bodygrip trap and place a stick in the mud directly in front of the trigger (make sure the stick is outside the closing radius of the trap). Otter will typically swim around the stick and avoid the trigger.
- Use castor mound sets with foot traps set eight to 10 inches deep for hind foot catches (to avoid otter).
- When using cable devices, use a nine to 10 inch loop. Add loop “stops” to prevent the loop from closing tighter than a four inch diameter. At the water’s edge or on land, particularly if not using stops, place the bottom of the loop close to the ground. Also consider positioning the lock farther back from top-center to decrease the sensitivity of the device. Do not “load” snares; this will further reduce sensitivity.
- Gang-set active beaver areas (set an equal number of traps for the anticipated number of beavers). Catch beaver as fast as possible, and pull traps. Avoid leaving traps set for extended periods trying to catch the last beaver.
- When trapping under ice, make baited sets between active lodges/dens and food caches/piles.
- Carry a catchpole or other device to assist with releasing live-restrained otter.
- For more information on otter avoidance and proper trigger configurations to use for bodygrip traps to capture beaver, see the Trapper Education Student Manual: A Guide for Trappers in the United States published by the Association of Fish and Wildlife Agencies at http://www.fishwildlife.org/furbearer_resources.html
- Always check your state’s trapping regulations for guidance, specific restrictions or prohibitions related to otter take while beaver trapping.



General Overview of Traps Meeting BMP Criteria for River Otters in the United States

Two basic types of traps were tested for river otters: foothold traps, and bodygrip traps. Examples, brief descriptions, and mechanical details of the various devices are given in the next section.

Table OT1. Overview of traps meeting BMP criteria** for river otters in the United States.

Trap Category	Jaw/Frame Characteristics	Inside Jaw/Frame Spread at Dog*	Inside Width at Jaw/Frame Hinge Posts*	
† Coil-spring	Unmodified	5	5	
† Longspring	Unmodified	3 ⁷ / ₈	3 ⁷ / ₁₆	
	Double jaws	3 ⁷ / ₈	3 ⁷ / ₁₆	
	Height of Trap Window*	Width of Trap Window*	Frame Wire*	Spring Wire*
†† Bodygrip	6 ⁷ / ₈ - 10 ¹ / ₈	7 - 10 ⁷ / ₁₆	1/4 - 5/16	1/4 - 5/16

* Inches

** Any size of foothold traps or bodygrip traps with the above measurements or larger measurements, which are commonly used for river otter, also meet BMP criteria for use in submersion sets for this species; foothold sizes commonly designated as 11, 1.5, 1.65, 1.75, 2, 3, 4, 5, and bodygrip sizes commonly designated as 220, 280, 330.

† No foothold trap tested (Coil-spring or Longspring) met BMP criteria for efficiency.

†† All bodygrip traps tested had two springs.

General Considerations When Trapping River Otters

Foothold Traps

- Many currently-used trap models meet specifications for animal welfare, safety, selectivity and practicality. No foothold trap tested met BMP criteria for efficiency.
- Can be used to capture several furbearer species
- Capture and hold animals alive, allowing for release

Bodygrip Traps

- Many currently-used trap models meet specifications
- Should be placed so that the rotating jaws close on the top and bottom of the captured animal's neck (Figure OT2)
- Can be used to capture several furbearer species
- Trigger configurations may be modified, and tension-adjustable triggers are available to help improve selectivity
- Allow for use in locations and in weather conditions where other traps are less effective or inappropriate
- May not be appropriate in some areas because captured animals are killed by the trap

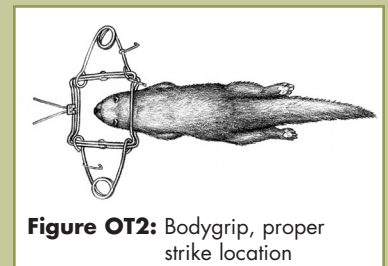

Figure OT2: Bodygrip, proper strike location



Safe Use of Bodygrip Traps

By design, bodygrip traps must close with considerable force to humanely dispatch and efficiently capture wild furbearers. This is particularly true of larger sized and “magnum” type bodygrip traps. As a result, users should take special precautions to avoid potential injury when using these devices. Trappers should be familiar with the safe and efficient use of bodygrip traps and these are best learned in trapper education courses.

A setting tool (Figure OT3a) should be used to compress trap springs when setting large and magnum bodygrip traps. Use of a setting tool will not only make setting traps easier, it will make setting traps safer by allowing the trapper to keep hands and fingers away from the jaws (Figure OT3b). Most bodygrip traps that have double springs are equipped with spring latches that hold each spring compressed, and the trapper should use these latches on both trap springs. A safety gripper (Figure OT4a) should also be attached to the jaws when the jaws are moved to the set position (Figure OT4b). This will prevent the trap from accidentally closing. The above safety devices protect the trapper and make it easier to set, position and anchor the trap safely. Safety devices should be disengaged only when the set is completed.

If you are accidentally caught in a bodygrip trap you need to know how to free yourself. A setting tool is the most effective means to freeing yourself and should be used to compress the springs or jaws. You should always have one in reach when setting and placing bodygrip traps. In the event you are not able to reach one or use it with one arm, you should always carry a four foot piece of rope. The rope should have a loop tied on one end and should be stored in a pocket that can be easily accessed by either hand. You can use the rope to free yourself as follows:

- 1) Thread the rope through the eyes of one of the springs (Figure OT5a).
- 2) Bring the rope around and thread it back through the eyes a second time (Figure OT5b).
- 3) Place your foot in the looped end of the rope and pull the other end with your free hand until you can set the safety latch for that spring. (Figure OT5c). You may need to do this to both springs to completely free yourself.



Figure OT3a. Setting tool

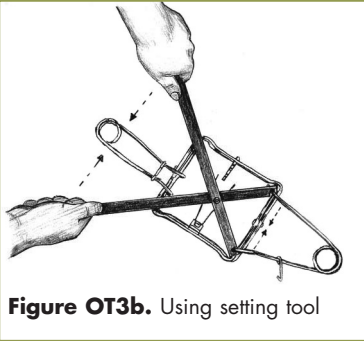

Figure OT3b. Using setting tool



Figure OT4a. Safety gripper



Figure OT4b. Using safety gripper

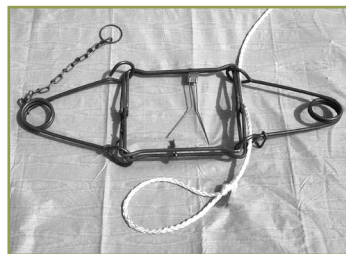

Figure OT5a. Step 1

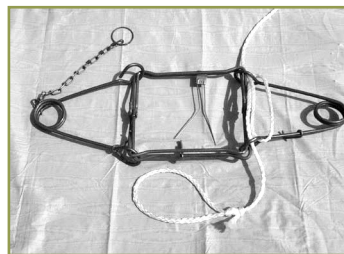

Figure OT5b. Step 2

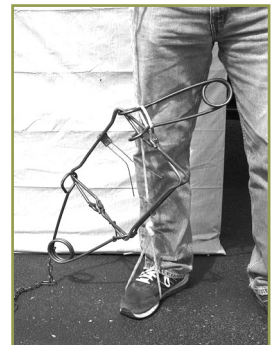

Figure OT5c. Step 3



Specifications of Traps Meeting BMP Criteria for River Otters in the United States

As more capture devices are tested and new information becomes available, they will be added to an updated list. Mechanical descriptions of tested traps are given as an aid to trappers or manufacturers who may wish to measure, build or modify traps to meet these specifications (Figures OT6a and OT6b). Also, other commercially available traps, modified traps, or other capture devices not yet tested may perform as well as, or better than the listed BMP traps. References to trap names are provided to identify the specific traps tested. This list is provided for information purposes only and does not imply an endorsement of any manufacturer.

Average mechanical measurements are rounded to the nearest $\frac{1}{16}$ inch. There may be up to a $\frac{1}{8}$ inch variation in specifications on the part of the manufacturer. Manufacturers use recognizable names, such as "No. 2" coil-spring, to identify certain traps. However, there is no standardized system linking mechanical design features with trap names. The mechanical features of these traps are listed so that similar traps may be identified. The performance of anchoring systems was not specifically evaluated, however, methods of attachment are described for informational purposes.

Unmodified Jaws (Figures OT7a and OT7b)

Average Mechanical Description and Attributes

Inside jaw spread (at dog): 5 inches

Inner width: $4\frac{1}{2}$ inches

Inside width at jaw hinge posts: 5 inches

Jaw width: $\frac{1}{2}$ inch smooth round jaw

Jaw thickness: $\frac{1}{8}$ inch

Main trap springs: Two 0.145 inch diameter wire coil-springs

Base plate: Not reinforced

Any trap that has similar specifications may be considered a BMP trap regardless of brand or source of modification, although performance information on all other BMP criteria (see Introduction: "Criteria for Evaluation of Trapping Devices" pages 4-6) needs to be considered as well. The trap tested was the Woodstream™ Victor No. 2 coil-spring.

Additional Information

- Use in live restraint or submersion sets.
- Chain attachment used in trap testing: 12 to 18 inch center-mounted with three swivels, one in-line shock spring, and anchored with a stake. When using submersion sets, chain length should be short enough to prevent captured animals from resurfacing.
- Selectivity features: Brass pan tension machine screw; pan tension was set so two to four pounds of pressure triggered the trap, and was checked and readjusted as needed after every capture.
- Safety considerations: To allow the release of otters from restraining foothold traps in a safe manner, special precautions should be taken. Choose a method which allows the otter to be shielded from the trapper, such as a board with a notch cut in the bottom that can be placed over the trapped limb. This will allow safe access to the captured limb.
- Special considerations for practicality: This device also meets BMP criteria for beaver, mink, muskrat and nutria in submersion sets and Eastern coyotes.

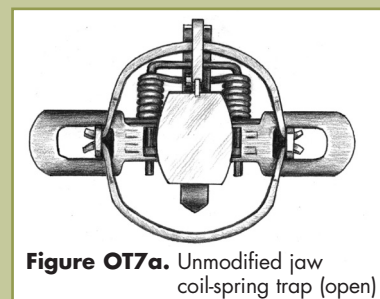
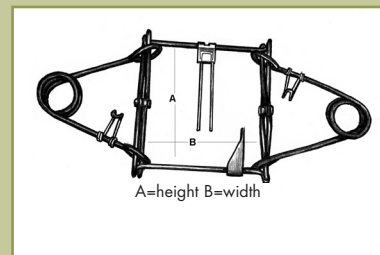
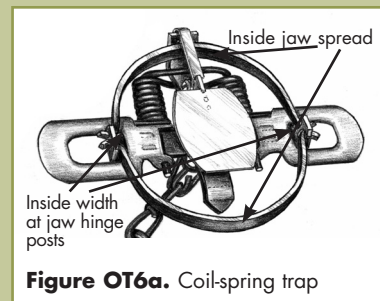

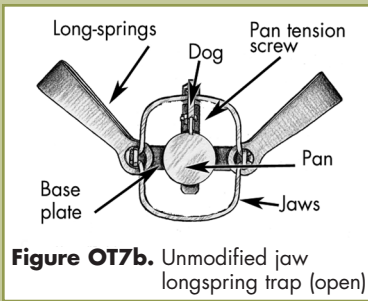

Figure OT7b. Unmodified jaw longspring trap (open)

Average Mechanical Description and Attributes

Inside jaw spread (at dog): 3 ⁷/₈ inches
 Inner width: 3 ¹/₈ inches
 Inside width at jaw hinge posts: 3 ⁷/₁₆ inches
 Jaw width: ¹/₂ inch
 Jaw thickness: ¹/₈ inch
 Length of main trap springs: 4 ³/₈ inches
 Thickness of main trap springs: ¹/₁₆ inch
 Width of main trap springs: 1 ¹/₂ inches narrowing to ⁵/₈ inch
 Base plate: Not reinforced
 Pan stop: None

Any trap that has similar specifications may be considered a BMP trap regardless of brand or source of modification, although performance information on all other BMP criteria (see Introduction: "Criteria for Evaluation of Trapping Devices" pages 4-6) needs to be considered as well. The trap tested was the Sleepy Creek No. 11 double-longspring trap.

Additional Information

- Use in live restraint or submersion sets.
- Chain attachment used in trap testing: 12 to 18 inch center-mounted with three swivels, one in-line shock spring, and anchored with a stake. When using submersion sets, chain length should be short enough to prevent captured animals from resurfacing.
- Selectivity features: Brass pan tension machine screw; pan tension was set so two to four pounds of pressure triggered the trap, and was checked and readjusted as needed after every capture.
- Safety considerations: To allow the release of otters from restraining foothold traps in a safe manner, special precautions should be taken. Choose a method which allows the otter to be shielded from the trapper, such as a board with a notch cut in the bottom that can be placed over the trapped limb.
- Special considerations for practicality: This device also meets BMP criteria for beaver, mink, muskrat and nutria in submersion sets.

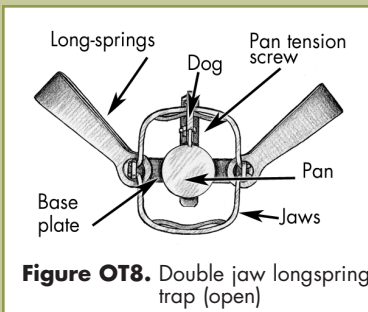

Figure OT8. Double jaw longspring trap (open)

Double Jaw (Figure OT8)

Average Mechanical Description and Attributes

Inside jaw spread (at dog): 3 ⁷/₈ inches
 Inner width: 3 ¹/₈ inches
 Inside width at jaw hinge posts: 3 ⁷/₁₆ inches
 Jaw width: ¹/₂ inch
 Jaw thickness: ¹/₈ inch
 Length of main trap springs: 4 ³/₈ inches
 Thickness of main trap springs: ¹/₁₆ inch
 Width of main trap springs: 1 ¹/₂ inches narrowing to ⁵/₈ inch
 Base plate: Not reinforced
 Pan stop: None



Any trap that has similar specifications may be considered a BMP trap regardless of brand or source of modification, although performance information on all other BMP criteria (see Introduction: "Criteria for Evaluation of Trapping Devices" pages 4-6) needs to be considered as well. The trap tested was the Sleepy Creek No. 11 double-longspring trap with double jaws.

Additional Information

- Use in live restraint or submersion sets.
- Chain attachment used in trap testing: 12 to 18 inch center-mounted with three swivels, one in-line shock spring, and anchored with a stake. When using submersion sets, chain length should be short enough to prevent captured animals from resurfacing.
- Selectivity features: Brass pan tension machine screw; pan tension was set so two to four pounds of pressure triggered the trap and was checked and readjusted as needed after every capture.
- Safety considerations: To allow the release of otters from restraining foothold traps in a safe manner, special precautions should be taken. Choose a method which allows the otter to be shielded from the trapper, such as a board with a notch cut in the bottom that can be placed over the trapped limb.
- Special considerations for practicality: This device also meets BMP criteria for beaver, mink, muskrat and nutria in submersion sets.



Bodygrip Traps (Figure OT9–OT20)

Average Mechanical Description and Attributes

Height of trap window: 6 ⁷/₈ inches

Width of trap window: 7 ¹/₄ inches

Diameter of frame wire: ¹/₄ inch

Diameter of spring wire: ¹/₄ inch

Additional clamping bar: None, but does have a magnum bend which eliminates the gap between the jaws when the trap is closed

Safety features: Safety latches on springs

Any trap that has similar specifications may be considered a BMP trap regardless of brand or source of modification, although performance information on all other BMP criteria (see "Criteria for Evaluation of Trapping Devices": Introduction pages 4-6) needs to be considered as well. The trap tested was the Belisle Super X™ 220 bodygrip trap.

Additional Information

- Selectivity features: Triggers may be configured to improve selectivity
- Safety considerations: This trap has complete jaw closure. The use of safety devices such as setting tongs and a safety gripper is highly recommended, and trappers should familiarize themselves with emergency release methods discussed in the "Safe Use of Bodygrip Traps" section.
- Special considerations for practicality: This device also meets BMP criteria for fisher and raccoon.



Figure OT9. Bodygrip trap



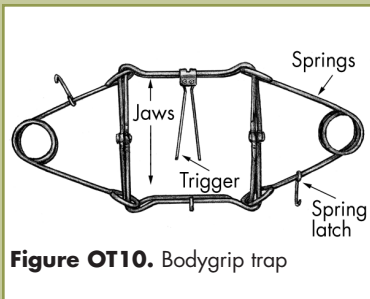

Figure OT10. Bodygrip trap

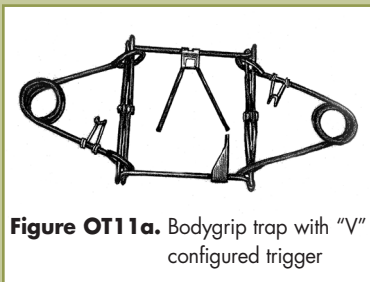

Figure OT11a. Bodygrip trap with "V" configured trigger

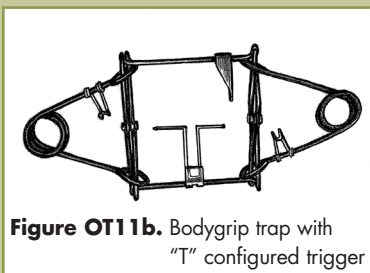

Figure OT11b. Bodygrip trap with "T" configured trigger



Figure OT12. Bodygrip trap

Average Mechanical Description and Attributes

Height of trap window: 6 7/8 inches
 Width of trap window: 7 inches
 Diameter of frame wire: 1/4 inch
 Diameter of spring wire: 1/4 inch
 Additional clamping bar: None
 Safety features: Safety latches on springs

Any trap that has similar specifications may be considered a BMP trap regardless of brand or source of modification, although performance information on all other BMP criteria (see Introduction: "Criteria for Evaluation of Trapping Devices" pages 4-6) needs to be considered as well. The trap tested was the Woodstream Oneida Victor 220 Conibear™ bodygrip trap.

Additional Information

- Chain attachment used in trap testing: 18 inch, anchored with a stake.
- Use in submersion sets only.
- Selectivity features: Triggers were configured in either a "V" or "T" shape during testing (Figures OT11a and OT11b).
- Safety considerations: Use of setting tongs and safety gripper is recommended.
- Special considerations for practicality: This device also meets BMP criteria for raccoon and nutria, and in submersion sets for beaver, nutria and muskrat.



Average Mechanical Description and Attributes

Height of trap window: 7 inches
 Width of trap window: 7 1/16 inches
 Diameter of frame wire: 1/4 inch
 Diameter of spring wire: 1/4 inch
 Additional clamping bar: None, but does have a magnum bend which eliminates the gap between the jaws when the trap is closed
 Safety features: Safety latches on springs

Any trap that has similar specifications may be considered a BMP trap regardless of brand or source of modification, although performance information on all other BMP criteria (see "Criteria for Evaluation of Trapping Devices": Introduction pages 4-6) needs to be considered as well. The trap tested was the LDL C™ 220 Magnum bodygrip trap.

Additional Information

- Selectivity features: Triggers may be configured to improve selectivity.
- Safety considerations: This trap has complete jaw closure. The use of safety devices such as setting tongs and a safety gripper is highly recommended, and trappers should familiarize themselves with emergency release methods discussed in the "Safe Use of Bodygrip Traps" section.
- Special considerations for practicality: This device also meets BMP criteria for fisher and raccoon.



Average Mechanical Description and Attributes

Height of trap window: 7 ¹/₁₆ inches

Width of trap window: 7 ¹/₁₆ inches

Diameter of frame wire: ¹/₄ inch

Diameter of spring wire: ¹/₄ inch

Additional clamping bar: None

Safety features: Safety latches on springs

Any trap that has similar specifications may be considered a BMP trap regardless of brand or source of modification, although performance information on all other BMP criteria (see "Criteria for Evaluation of Trapping Devices": Introduction pages 4-6) needs to be considered as well. The trap tested was the LDL C™ 220 bodygrip trap.

Additional Information

- Selectivity features: Triggers may be configured to improve selectivity.
- Safety considerations: This trap has complete jaw closure. The use of safety devices such as setting tongs and a safety gripper is highly recommended, and trappers should familiarize themselves with emergency release methods discussed in the "Safe Use of Bodygrip Traps" section.
- Special considerations for practicality: This device also meets BMP criteria for raccoon.



Average Mechanical Description and Attributes

Height of trap window: 7 ¹/₈ inches

Width of trap window: 7 inches

Diameter of frame wire: ¹/₄ inch

Diameter of spring wire: ¹/₄ inch

Additional clamping bar: None

Safety features: Safety latches on springs

Any trap that has similar specifications may be considered a BMP trap regardless of brand or source of modification, although performance information on all other BMP criteria (see "Criteria for Evaluation of Trapping Devices": Introduction pages 4-6) needs to be considered as well. The trap tested was the Rudy™ 220 Plus bodygrip trap.

Additional Information

- Selectivity features: Triggers maybe configured to improve selectivity.
- Safety considerations: This trap has complete jaw closure. The use of safety devices such as setting tongs and a safety gripper is highly recommended, and trappers should familiarize themselves with emergency release methods discussed in the "Safe Use of Bodygrip Traps" section.
- Special considerations for practicality: This device also meets BMP criteria for raccoon and fisher.



Figure OT13. Bodygrip trap



Figure OT14. Bodygrip trap





Figure OT15. Bodygrip trap

Average Mechanical Description and Attributes

Height of trap window: 8 ¹/₈ inches
 Width of trap window: 8 ⁵/₃₂ inches
 Diameter of frame wire: ¹/₄ inch
 Diameter of spring wire: ¹/₄ inch
 Additional clamping bar: None, but does have a magnum bend which eliminates the gap between the jaws when the trap is closed
 Safety features: Safety latches on springs

Any trap that has similar specifications may be considered a BMP trap regardless of brand or source of modification, although performance information on all other BMP criteria (see "Criteria for Evaluation of Trapping Devices": Introduction pages 4-6) needs to be considered as well. The trap tested was the Belisle Super X™ 280 bodygrip trap.

Additional Information

- Selectivity features: Triggers may be configured to improve selectivity
- Safety considerations: This trap has complete jaw closure. The use of safety devices such as setting tongs and a safety gripper is highly recommended, and trappers should familiarize themselves with emergency release methods discussed in the "Safe Use of Bodygrip Traps" section.
- Special considerations for practicality: This device also meets BMP criteria for beaver.



Figure OT16. Bodygrip trap

Average Mechanical Description and Attributes

Height of trap window: 8 ³/₁₆ inches
 Width of trap window: 8 ⁹/₁₆ inches
 Diameter of frame wire: ¹/₄ inch
 Diameter of spring wire: ¹/₄ inch
 Additional clamping bar: None, but does have a magnum bend which eliminates the gap between the jaws when the trap is closed
 Safety features: Safety latches on springs

Any trap that has similar specifications may be considered a BMP trap regardless of brand or source of modification, although performance information on all other BMP criteria (see "Criteria for Evaluation of Trapping Devices": Introduction pages 4-6) needs to be considered as well. The trap tested was the LDL C™ 280 Magnum bodygrip trap.

Additional Information

- Selectivity features: Triggers may be configured to improve selectivity.
- Safety considerations: This trap has complete jaw closure. The use of safety devices such as setting tongs and a safety gripper is highly recommended, and trappers should familiarize themselves with emergency release methods discussed in the "Safe Use of Bodygrip Traps" section.
 - Special considerations for practicality: This device also meets BMP criteria for beaver.



Average Mechanical Description and Attributes

Height of trap window: 8 inches
Width of trap window: 8 1/2 inches
Diameter of frame wire: 5/16 inch
Diameter of spring wire: 1/4 inch
Additional clamping bar: Yes
Safety features: Safety latches on springs

Any trap that has similar specifications may be considered a BMP trap regardless of brand or source of modification, although performance information on all other BMP criteria (see "Criteria for Evaluation of Trapping Devices": Introduction pages 4-6) needs to be considered as well. The trap tested was the Sauvageau™ 2001-8 bodygrip trap.

Additional Information

- Selectivity features: Triggers may be configured to improve selectivity.
- Safety considerations: This trap has complete jaw closure. The use of safety device such as setting tongs and a safety gripper is highly recommended, and trappers should familiarize themselves with emergency release methods discussed in the "Safe Use of Bodygrip Traps" section.
- Special considerations for practicality: This device also meets BMP criteria for beaver, fisher and raccoon.



Average Mechanical Description and Attributes

Height of trap window: 8 1/8 inches
Width of trap window: 8 1/8 inches
Diameter of frame wire: 5/16 inch
Diameter of spring wire: 5/16 inch
Additional clamping bar: None
Safety features: Safety latches on springs

Any trap that has similar specifications may be considered a BMP trap regardless of brand or source of modification, although performance information on all other BMP criteria (see "Criteria for Evaluation of Trapping Devices": Introduction pages 4-6) needs to be considered as well. The trap tested was the Rudy™ 280 bodygrip trap.

Additional Information

- Selectivity features: Triggers may be configured to improve selectivity.
- Safety considerations: This trap has complete jaw closure. The use of safety devices such as setting tongs and a safety gripper is highly recommended, and trappers should familiarize themselves with emergency release methods discussed in the "Safe Use of Bodygrip Traps" section.
- Special considerations for practicality: This device also meets BMP criteria for beaver.

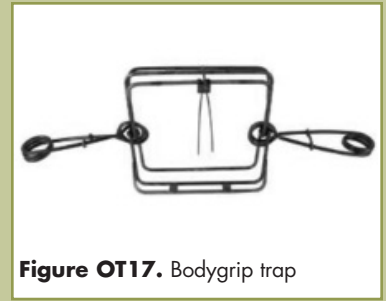

Figure OT17. Bodygrip trap



Figure OT18. Bodygrip trap



Average Mechanical Description and Attributes

Height of trap window: 8 ³/₈ inches
Width of trap window: 8 ³/₈ inches
Diameter of frame wire: ¹/₄ inch
Diameter of spring wire: ⁵/₁₆ inch
Safety features: Safety latches on springs

Any trap that has similar specifications may be considered a BMP trap regardless of brand or source of modification, although performance information on all other BMP criteria (see Introduction: "Criteria for Evaluation of Trapping Devices" pages 4-6) needs to be considered as well. The trap tested was the Woodstream Oneida Victor 280 Conibear™ bodygrip trap.

Additional Information

- Chain attachment used in trap testing: 18 inch, anchored with a stake.
- Use in submersion sets only.
- Selectivity features: Triggers were configured in either a "V" or "T" shape during testing (Figure OT10a and OT10b).
- Safety considerations: Use of setting tongs and safety gripper is recommended.
- Special considerations for practicality: This device also meets BMP criteria for beaver.



Figure OT19. Bodygrip trap

Average Mechanical Description and Attributes

Height of trap window: 10 ¹/₈ inches
Width of trap window: 10 ⁷/₁₆ inches
Diameter of frame wire: ⁵/₁₆ inch
Diameter of spring wire: ⁵/₁₆ inch
Additional clamping bar: None, but does have a magnum bend which eliminates the gap between the jaws when the trap is closed
Safety features: Safety latches on springs

Any trap that has similar specifications may be considered a BMP trap regardless of brand or source of modification, although performance information on all other BMP criteria (see "Criteria for Evaluation of Trapping Devices": Introduction pages 4-6) needs to be considered as well. The trap tested was the Belisle Super X™ 330 bodygrip trap.

Additional Information

- Selectivity features: Triggers may be configured to improve selectivity
- Safety considerations: This trap has complete jaw closure. The use of safety devices such as setting tongs and a safety gripper is highly recommended, and trappers should familiarize themselves with emergency release methods discussed in the "Safe Use of Bodygrip Traps" section.
- Special considerations for practicality: This device also meets BMP criteria for beaver.

Average Mechanical Description and Attributes

Height of trap window: 10 ¹/₄ inches

Width of trap window: 10 inches

Diameter of frame wire: ⁵/₁₆ inch

Diameter of spring wire: ⁵/₁₆ inch

Additional clamping bar: None

Safety features: Safety latches on springs

Any trap that has similar specifications may be considered a BMP trap regardless of brand or source of modification, although performance information on all other BMP criteria (see "Criteria for Evaluation of Trapping Devices": Introduction pages 4-6) needs to be considered as well. The trap tested was the Rudy™ 330 bodygrip trap.

Additional Information

- Selectivity features: Triggers may be configured to improve selectivity.
- Safety considerations: This trap has complete jaw closure. The use of safety devices such as setting tongs and a safety gripper is highly recommended, and trappers should familiarize themselves with emergency release methods discussed in the "Safe Use of Bodygrip Traps" section.
- Special considerations for practicality: This device also meets BMP criteria for beaver.



Average Mechanical Description and Attributes

Height of trap window: 9 ³/₄ inches

Width of trap window: 10 ³/₈ inches

Diameter of frame wire: ⁵/₁₆ inch

Diameter of spring wire: ⁵/₁₆ inch

Additional clamping bar: None

Safety features: Safety latches on springs

Any trap that has similar specifications may be considered a BMP trap regardless of brand or source of modification, although performance information on all other BMP criteria (see Introduction: "Criteria for Evaluation of Trapping Devices" pages 4-6) needs to be considered as well. The trap tested was the Woodstream Oneida Victor 330 Conibear™ bodygrip trap.

Additional Information

- Chain attachment used in trap testing: 18 inch, anchored with a stake.
- Selectivity features: Triggers were configured in a "V" shape during testing (OT10a).
- Safety considerations: Use of setting tongs and safety gripper is recommended.
- Special considerations for practicality: This device also meets BMP criteria for beaver.



Figure OT20. Bodygrip trap

